

Manual Alma Rally (Plus) & Alma Rally (Plus) Off- road

Version 2.0.3

For Software version 4.x.xx

Korsmit Rally Electronics

21-8-2020

Content

Content.....	1
Legend.....	3
Summary.....	4
1. Background/Introduction.....	5
2.Operation.....	6
Startup.....	6
View selection.....	6
Start a Special Stage.....	7
During the Special Stage.....	7
Change View.....	8
Change Sensor.....	8
Dim the screen light.....	8
Reset Trip1 to 0.....	8
Functions with unique External Buttons (next to the external TRIP or STOP button).....	8
End the Special Stage.....	9
3.Setup.....	10
Distance menu (<i>d</i> <i>IS</i>).....	11
Manual calibration adjustment (sensor 1 and 2) (<i>MAN 1</i> & <i>MAN 2</i>).....	11
Pulses per revolution (sensor 1 and 2) (<i>PPR 1</i> & <i>PPR 2</i>).....	11
Automatic Calibration (<i>AUTD</i>).....	11
Calibration Distance adjustment (<i>CLdS</i>).....	12
Manual adjustment Pulses (<i>ICdC</i>).....	12
View menu (<i>VIEW</i>).....	13
OPT menu (<i>OPT</i>).....	13
Troubleshoot.....	15
No distance counting.....	15
Only one of the screens resets when pressing the button.....	15
Only one of the displays work correctly.....	15
Anything else or the above does not work.....	15

4.Installation..... 16

 Tools 16

 Connections:..... 17

 Descriptions..... 19

 Countdown connection possibilities 19





 Sensors 21

 Dimmable Light mode 21

 Manual Distance adjustment buttons..... 22

 Separate TRIP1 from display 1 from TRIP1 from display 2..... 22





Legend

Layout	Knop	Main function
	TRIP	Reset Trip1 to 0 (for corner to corner measurement)
	STOP	Stop the stopwatch when driving over the finishline
	SELECT	Select the view in the display (1 button per display)
	DIM	Dim or un-dim the light of the screen and buttons for night driving

HOT = Views or menu stage

trP1 = Screens

Summary

- Start tripmaster by pressing .
- Wait until text message is ended.
- If you want to display another view on the display, select this by pressing .
- When arrived to startline of the Special Stage (and there is no movement of the car anymore), press  for at least two seconds until *Hot* flashes in the screen.
- Start driving (when you are allowed 😊). The *autostart* function will start the stopwatch.
- When crossing the finishline, press  to stop the stopwatch.
- When the light is too bright or not bright enough, press the  button.

1. Background/Introduction

The Alma Rally tripmaster is specially designed as a basic tripmaster with all necessary functions for driving rally. The Alma Rally Plus is 2 times the Alma Rally tripmaster in 1 box. It has (for each display) a stopwatch, 2 distances and a speedometer.

Next to these basic functions, an optional package can be activated that displays you average speed, the maximum driven speed on the stage and a sprint from 0 – 100.

Next to these views it has several additional functions and possibilities. It has the autostart function that starts the stage automatically when the car starts driving. The display and button light can be dimmed for perfect view during the day and night. It can be connected to the reverse lights and/or an external button to countdown, The trip values can be adjusted manually by two external buttons, it has autocalibration with changeable calibration distance and you can turn on/off some views per display for easy and fast scrolling.

The Alma Rally plus has also 2 separate connections for a probe so that two probes can be connected simultaneously. They have each their own calibration numbers and can be switched over independently of which view or status you are in.

The Alma Rally Plus can also be connected to 1 or more external displays to show certain information on a separate screen for example for the pilot.

Ofcourse, the Alma Rally Plus can be connected to external buttons and/or footpedal for easy trip-reset. Even the stop button and 1 select button can be connected to external buttons when a co-pilote sits a bit far from the tripmaster.





Because the Alma Rally Plus are really two tripmasters in 1 box, it has several benefits:

- There is always a backup
- You could even play with different calibration numbers

For this reason you have to take care that you do the calibration, viewselect, etc always for every tripmaster individually (but can be done simultaneously).

2.Operation

The Alma Rally has basically 4 different buttons with al 4 a main function:

Layout	Knop	Main function
	TRIP	Reset Trip1 to 0 (for corner to corner measurement)
	STOP	Stop the stopwatch when driving over the finish line
	SELECT	Select the view in the display (1 button per display)
	DIM	Dim or un-dim the light of the screen and buttons for night driving



However, most of the buttons have some extra functions to give the device extra functionality. We have tried to reduce this functionality to “less important” or that these functions are able to do with the manual in your hand, like setting up the setup menu.

In the summary you can find the basic operation of the alma Rally. In this chapter we will go more in depth how the tripmaster works and specially the additional functions.

Sometimes we will use some specialized words. Hereby the explanation:

<i>indication point</i>	the point in the most right side of the display.	
-------------------------	--	---

Startup

When the device is connected, you can start it by pressing  After that, a rolling text message (ALMA RALLY) will be displayed after which it will go to the view you had selected the last time. If you wanted to start the setup menu, you have to keep pressing the  button(s) of the tripmaster from which you want to enter the setup menu. For more instructions, see the setup chapter.

View selection

If you want to select a different view, you press the  button that belongs to the display you want to change. When pressing the button, a text with the item will shortly appear to indicate which view you have selected. The next view exist:

Tekst	View	Description
TRIP 1	TRIP 1	Distance measurement for - corner to corner or - roadbookpoint to roadbookpoint. Resettable with 
TRIP 2	TRIP 2	Distance measurement. The distance of the total Special Stage. This will only be resetted to 0 at the start of the Special Stage.
SPD	SPEED	Speedometer, the current speed you are driving.

<i>StP</i>	STOPWATCH	Stopwatch to measure the time on the Special Stage. Started at the start (automatically or manually) and ended on the finish line by pressing 
<i>ASPd</i>	AVERAGE SPEED	Average speed on the Special Stage. It is based on Trip2 and the Stopwatch.
<i>iSPd</i>	MAXIMUM SPEED	The maximum driven speed on the Special Stage. This is resetted when a new Special stage is started.
<i>0-100</i>	0-100 SPRINT	The time in which a speed of 100 is reached.

Start a Special Stage

To start a special stage, the tripmaster needs to be resetted and made ready for the Autostart function. For that we need the HOT stage: the stage in which the tripmaster is ready and will start counting when receiving a pulse from the sensor.

The Stage can be started in two ways:

- Manual Start
- Auto Start

The normal use is the use of the Autostart. When the car is standing still at the starting line and the car does not need to move anymore, you can activate the HOT stage by pressing the  button for at least two seconds until *Hot* flashes in the screen. When that is over, the indication point (the point at the most right side of the display, will start to blink. When you are allowed to start, the tripmaster will start when the first pulse from the sensor comes in. The Stopwatch and distance measurement will start and the indication point will be constantly on.

The tripmaster can be started manually by holding and releasing the  button. The tripmaster **starts when the button is released**. To avoid that the tripmaster is manually started by button bounce when the TRIP button is pressed during the HOT stage, the device can be set HOT while pressing the TRIP button. The display will also show a blinking *HOT* but the indication point will not start blinking..

During the Special Stage

These are the possible actions you can do during the Special Stage. **All these functions work of course also when you are not on the stage.**

Functions	Description
Change view	To display a different option
Change sensor	To use the other sensor
Dim the display and button light	To use the tripmaster at night or during the day
Reset TRIP 1 to 0	To start the distance value again
Increase/decrease the TRIP 1 & 2 manually	to manually adjust the trip values
Decrease TRIP 1 & 2 Automatically by driving a distance	To let the trip values count down instead of up.

Change View

By pressing the  button shortly, you can change the view. If some views are not activated, these views will be skipped (see chapter Setup menu, views). The possibility to deactivate certain views is done so that you can personalize your tripmaster and optimize the amounts of button presses you have to do to come to your desired view. The views are shown in the introductions section in the correct order of appearance.

Change Sensor

If you want to change the active sensor, you press the  button for a longer time. In the display the first or second point will light up as indication which sensor is active. Keep holding the button will switch the active sensor.

Dim the screen light

When the light is too bright or not bright enough, press the  button. The light will switch between the normal (maximum brightness) and the dimmed brightness.



If the dimmed brightness is not the desired level, you can adjust this setting by a potentiometer in the device. This is described in the installation manual.

Reset Trip1 to 0

To reset Trip 1, distance measurement to 0 and to restart counting, press the  button. The restart of the distance measurement will start at the release of the button. Trip2 can not be resetted during the stage.

When an external foot pedal and/or external button is used, this has the same function as the internal trip-reset button . The following section describes a less usual situation regarding the button setup.

2 resettable trips (TRIP1)

If 2 instead of 1 resettable trips are desired, also 2 reset buttons are desired. Our solution is that the external Trip-reset button can be detached from the internal trip-reset button (). This can be done by an internal jumper. This is described in the installation manual. If the jumper is not set, the external foot pedal and/or button will reset the TRIP1 value for 1 display, and the internal trip-reset button  for the other display.. When this setup is used also the function of the internal trip reset button is changed in other sections of the device, for example in the setup menu.

Functions with unique External Buttons (next to the external TRIP or STOP button)

Adjust trip distance values manually

With the connection of 2 external buttons, the TRIP1 and TRIP2 values can be adjusted. Depending on the connections of the device, this will change the values of 1 of the displays or both. How and where these buttons can be connected, please check the installation manual.

When one of the two buttons is pushed, the value of the trips will increase. With the other button, the values will decrease. In the background this will increase or decrease the amount of measured

pulses by the device. When the buttons are held for a longer time, the change in value will go faster. The amount of distance that will be changed depends on the amount of pulses per button click. This can be set in the setup menu. Please see the setup menu section of how to do this. The second factor that the change in distance depends on is the calibration information of the sensor. Therefore there can be a difference in change between the measurement per sensor when this manual adjustment is done when the sensors have (significant) different calibration values. See also the setup menu section for more information about the calibration information.

Countdown of TRIP distances

When the device is in countdown mode, the trip distances are counted down by the driven distance.

The countdown mode can be activated by two possibilities, by connection to the reverse backlight sensors or by an external button or both. How this must be connected you can read in the installation manual. By connecting the sensors creatively, also a non-counting setup by a 3-stand toggle switch can be created. How to connect this, is also described in the installation manual.

End the Special Stage

When crossing the finish line, press  to stop the stopwatch and to end the special Stage. While normally the roadbooks are always made from the beginning of the Special Stage, only the stopwatch is stopped. The distance measurement of the total stage (TRIP 2) will not stop counting so that it keeps being in sync with your roadbook.

The STOP button can also be connected to an external button. In this case, the external button is an exact copy of the working of the **STOP** button () on the device.



3.Setup

The Alma Rally Plus are 2 times the Alma Rally in 1 enclosure. The setup menu can be done for each tripmaster separately or, with a little practice, can be done simultaneously. When you want that, all described actions for pressing the  button must be done for both buttons and therefore for both displays simultaneously. In the further description of the setup menu this will be assumed as knowledge and will not be mentioned at each individual point.

When the Alma Rally starts up, it starts with a rolling text "Alma Rally". When we need to go to the calibration menu, the  button must be pressed during the end of the message. Keep pressing the button until the words **CLB** (calibration menu) will appear for a short time to indicate that the calibration menu is entered.

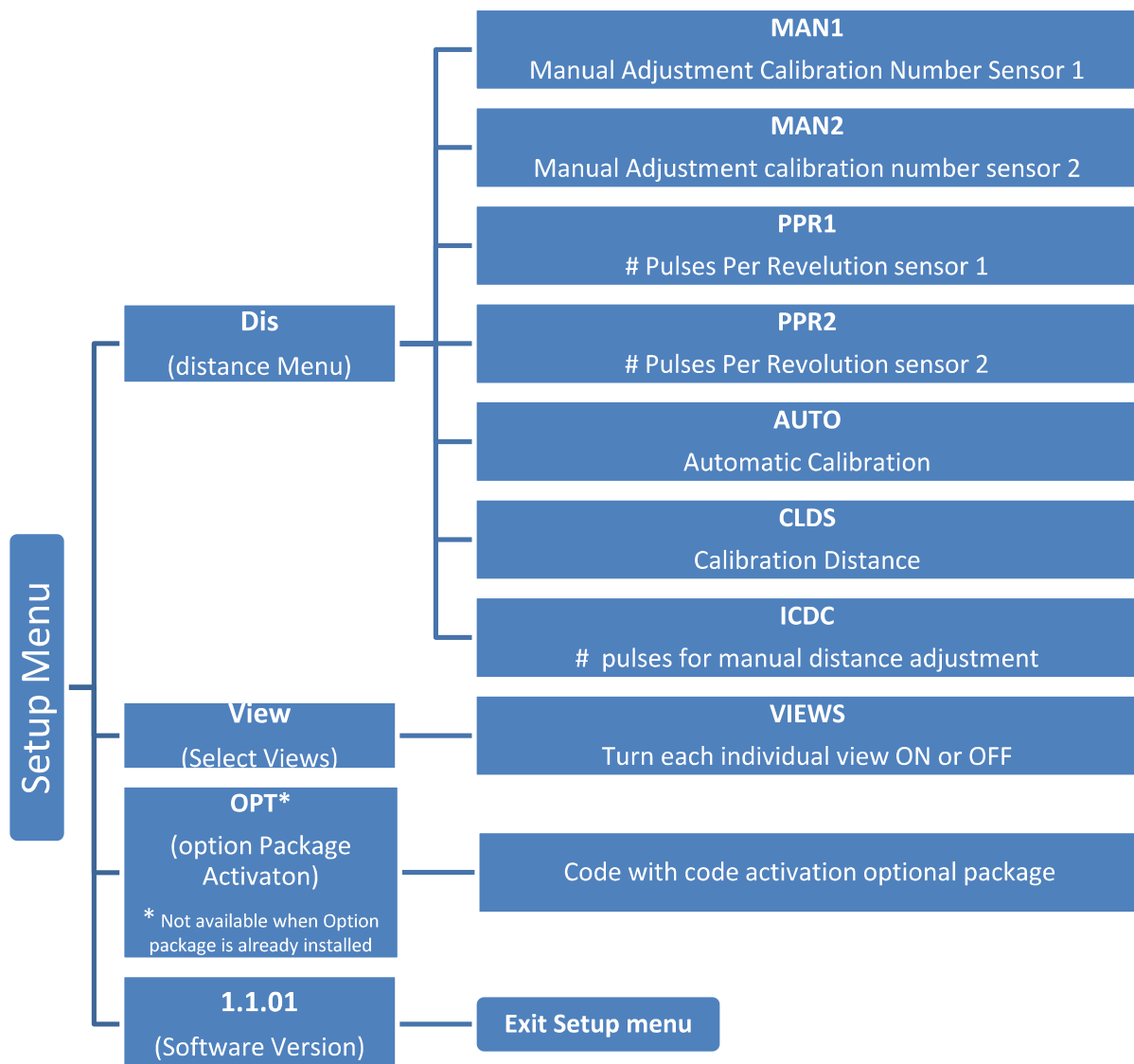
The structure of the Setup menu is given in the next overview.





To step through the different menu items within a setup level, please use the  to select the next item. To activate a certain menu item, press the  button.

To exit the setup menu, press the  button when the software version is selected.

Distance menu (*d*, *5*)



The distance menu has several menu items that are related to the distance measurement.

To step through the different menu items within the distance level, please use the  to select the next item. To activate a certain menu item, press the  button.

Per sensor, the combination of the calibration value and the amount of pulses per wheel revolution, is the complete calibration information per sensor.

Manual calibration adjustment (sensor 1 and 2) (*īAn 1* & *īAn 2*)

In this item, the value of the calibration appears. This is the wheel circumference in millimeters. This can be manually adjusted if a small deviation occurs (or if a different set of tires is put under the car with a certain calibration number).



When pressing the  button, the value will increase or decrease. When **holding** the  button, the word *dEc* or *inc* will appear, indicating that a button press will increase or decrease the value. When pressing the  button the value will increase or decrease rapidly.

To leave the menu item, the  button must be pressed and the value is saved. The menu will go back to the *Distance menu*.

The value can be set between 1000 and 9.999 mm.

Pulses per revolution (sensor 1 and 2) (*PPr 1* & *PPr 2*)

In this item, the amount of pulses per wheel circumference (pulses per 1 revolution of the wheel) can be adjusted. If this number can not be exactly set, then it is sufficient to use a number that is the closest so that finally the calibration number is a number between 1000 and 9999.

When pressing the  button, the value will increase or decrease. When **holding** the  button, the word *dEc* or *inc* will appear, indicating that a button press will increase or decrease the value. When pressing the  button the value will increase or decrease rapidly.







To leave the menu item, the  button must be pressed and the value is saved. The menu will go back to the *Distance menu*.

The value can be set between 1 and 20 pulses.

Automatic Calibration (*AU&D*)





To do an automatic calibration we need to drive a defined distance. This distance can be adjusted in the next section of this menu. This distance will be called Caldis (calibration Distance).

In the menu first the Caldis will appear to indicate we need to go and drive this distance. When we are at the beginning of the calibration section, we need to press the  button to start the

calibration. We will see the incoming pulses (NOT meters!!) counting in the screen. When we want to see the pulses coming in on the other sensor, we can press the  button to switch between sensors. The sensor can be recognized by the point in the screen (position 1 and position 2). When arriving at the end of the calibration section, we need to press the  button again. The newly measured calibration value will appear in the screen. Also the measured calibration value of the other sensor can be shown by pressing the  button. When these values can be accepted, the  button needs to be pressed to accept the new value. The value will be saved and *dOnE* will appear in the screen. If, for any reason, the value is not acceptable, the tripmaster needs to be turned off before pressing the  button. After pressing the  button, the tripmaster will go back to the *Distance menu*.

Calibration Distance adjustment (CLd5)





In this item, the value of the calibration distance appears. This is the distance which will be used during the automatic calibration.

When pressing the  button, the value will increase or decrease. When **holding** the  button, the word *dEc* or *inc* will appear, indicating that a button press will increase or decrease the value. When pressing the  button the value will increase or decrease rapidly. To leave the menu item, the  button must be pressed and the value is saved. The menu will go back to the *Distance menu*.

The value can be set between 0 and 20.000 meter. A value above 9.999 meter will be rounded at 10 meters and can be recognized about the point in the display.

Manual adjustment Pulses (I CdC)

In this item, the amount of pulses per button press of the external buttons for manual adjustment, can be adjusted. Every time the Increase button will be pressed, this amount of pulses will be added to total pulses. Every time the decrease button is pressed, this amount of pulses will be deducted from the total amount. The total amount of pulses is, of course, used for the calculation of the distance.

When pressing the  button, the value will increase or decrease. When **holding** the  button, the word *dEc* or *inc* will appear, indicating that a button press will increase or decrease the value. When pressing the  button the value will increase or decrease rapidly. To leave the menu item, the  button must be pressed and the value is saved. The menu will go back to the *Distance menu*.

The value can be set between 0 and 2555 pulses.

View menu (U, E!)



In this menu, all views on the display can be turned On or Off. When you turn the views of which you do not use, you can scroll faster to the views you do want to use. While you can adjust the top display separately from the bottom display with the Alma Rally Plus, you can use 1 display for certain views and the other display for other views and make the tripmaster very efficient when you want to display other information at the screen.

While certain items can not be displayed if you do not have the Optional package installed, some of the views you will not be able to select.

The different views have a numeric code in this section from 1 -7 according the next table.

Tekst	View	Number
TrP1	TRIP 1	1
TrP2	TRIP 2	2
SPd	SPEED	3
StP	STOPWATCH	4
ASPD	AVERAGE SPEED	5
MSPD	MAXIMUM SPEED	6
0-100	0-100 SPRINT	7

When it starts, the display will show on the left the number and on the right the current status (**On** or **Off**).





When pressing the  button, the value will turn **On** or **Off**. When pressing the  button the next view value will be selected with the current status.

To leave the menu item, the  button must be pressed and the value is saved. The menu will go back to the *Distance menu*.

OPT menu (OPT)

When activating this menu, a device number will appear. With this number and the software version, you can get a code from KRE with which you can activate the optional package. **If you have an Alma Rally Plus, do not forget to get the codes for both displays.**

To go to the next step, press the  button. In the next screen you have to enter the activation code you have received.

When pressing the  button, the value will increase or decrease. When **holding** the  button, the word *dEc* or *inc* will appear, indicating that a button press will increase or decrease the value. When pressing the  button the value will increase or decrease rapidly. To leave the menu item, the  button must be pressed. When you have entered the correct code, your optional package will now be activated. The menu will go back to the *Distance menu*. After this, it might be necessary or interesting to set-up the view menu again while there are new views..

Troubleshoot

No distance counting

- Check if the correct sensor is selected
- Check if you have reasonable calibration information and be aware it only starts displaying at 10 meters
- For easy checking if pulses come in, go to the setup menu and to the auto calibration. If activated, you should see the pulses counting in the screen.
- Check the wiring
- With a proximity sensor, check if the led on the back goes on when it is activated
- To test the tripmaster separately from the sensor:
 - o Detach the sensor signal wire
 - o Make a wire to the sensor input
 - o Make pulses by ticking this cable to the gnd.
 - o If these pulses are coming in, the device is correct and the problem is at the sensor side.
- You can test a sensor separately but normally, when the led goes on, it should be oke.
 - o Put power on the sensor
 - o Take a multimeter and put it on short circuit measurement (normally called the beeping mode 😊)
 - o Connect your black measuring pin to the gnd.
 - o Connect your red measuring pin to the signal from the sensor.
 - o When the sensor is active, your multimeter should beep or measure a short circuit.
- If one of the items does not work according the last steps, please contact KRE. Otherwise, please check your cables again.

Only one of the screens resets when pressing the button

- Check if in both displays the trp1 is active
- Check the jumper setting in the tripmaster

Only one of the displays work correctly

- Be sure you have done the calibration for both displays separately. See the setup menu. They can be done simultaneously but should be done both. they should have the same calibration information per sensor (calibration value **AND** pulses per revolution).

Anything else or the above does not work

Contact KRE. The contact information can be found at www.korsmit.com

4.Installation

IMPORTANT REMARKS:

- -The Alma Rally Plus has no fuse or protection against reverse polarity. Make sure all connections are correct before putting power on the device. Also make sure you do not remove or install any wires when there is power on the device while if you touch the printed circuit board with a GND or 12 Volt wire, you can make a short circuit which likely destroys the device!!
- Make also sure that the wires are completely under and inside the contact blocks and there are no parts of the wires exposed to the pcb.
- **Use small wires.** (AWG26 or 24) There is very little current used and big wires do not fit into the housing. Specially if you want to connect all options.
- Make sure that the pin-headers on the printed circuit board do not insert into your wires and nothing is blocked while closing the housing.

Tools

- Small 2 mm screwdriver
- Allen key
 - o 2mm for Alma Rally Plus
 - o 2,5 mm for Alma rally
- Drill etc to attach enclosure to dashboard

Steps

- Install sensors
- Install all cables for the options you want to use
 - o Use small wires
 - o Make sure they are long enough and no stress on them
 - o Make sure they are not touching sharp edges
 - o Make sure the main incoming 12 Volt is fused (with appr. 500mA to about 2A max)
- Install the box to the dash
 - o Make sure you use the bolt head inside the box to have minimum bolt length in the box

Connections:

Picture Alma Rally

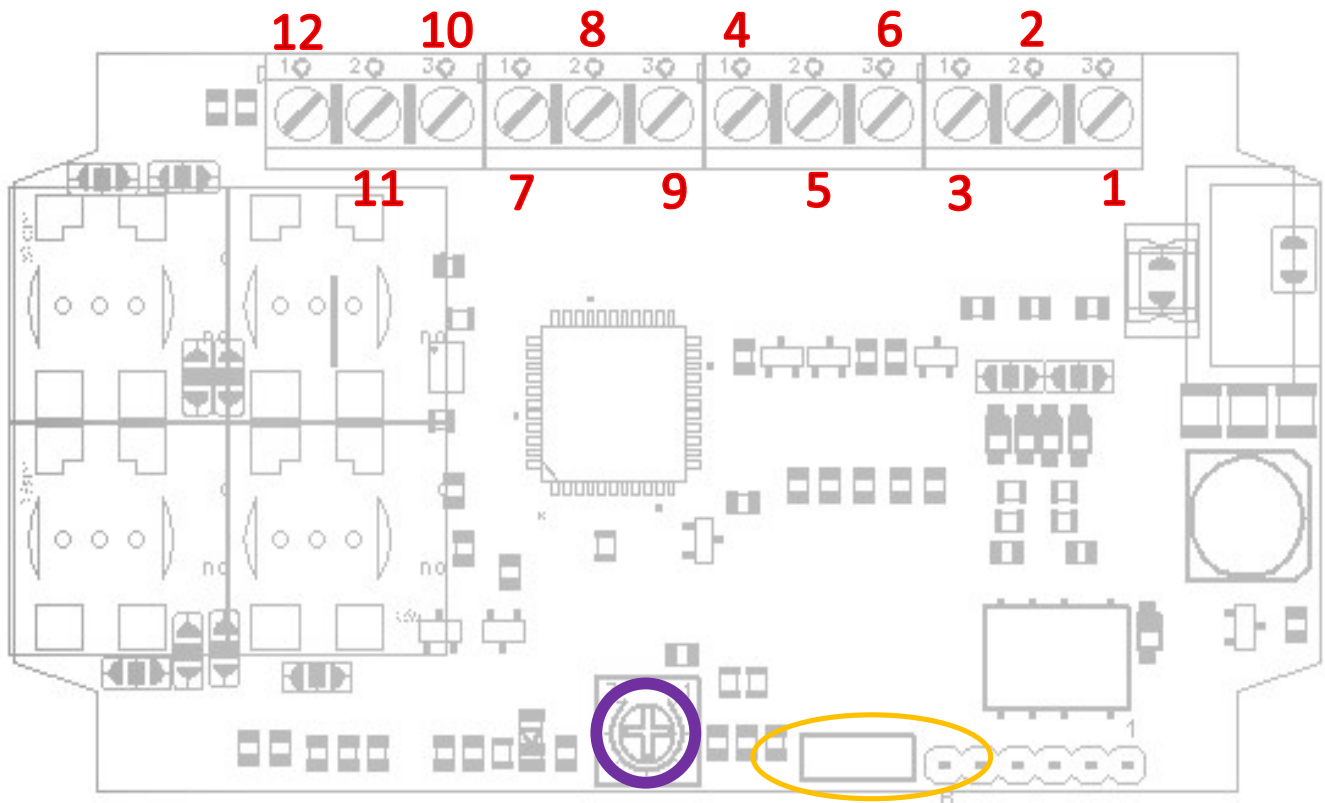

Picture Alma Rally Plus

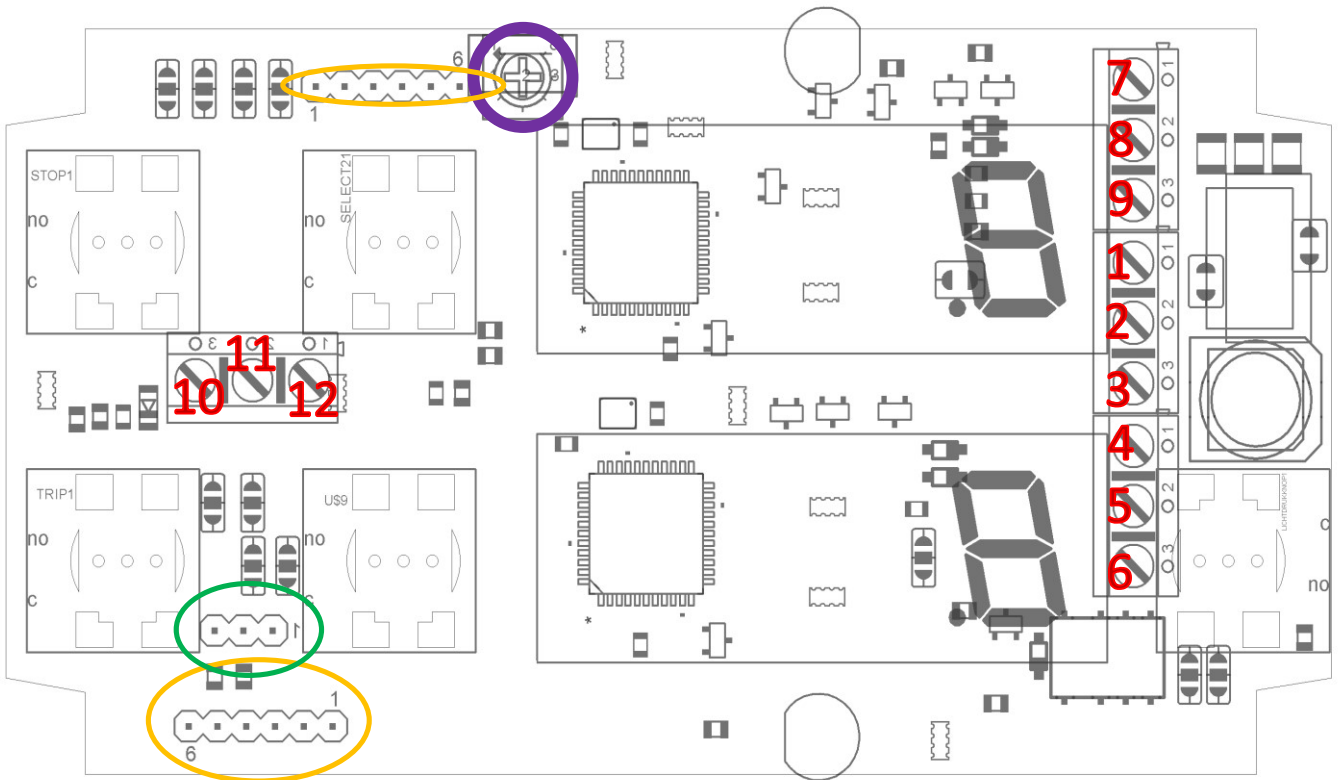

Connectors (screw terminals)

1	2	3	4	5	6
+ 12 – 24 Volt (in)	N.C.	GND (in)	Input Puls Sensor 1	Input pulse sensor 2	Ext SELECT Button for display 2
Obligatory	N.C.	Obligatory	Obligatory	Optional	Optional

7	8	9	10	11	12
+ 5 Volt (out) for External Display	Signal to external display	GND (out) for External Display	+12V reverse light or External button	Ext STOP Button	Ext TRIP Button
Optional	Optional	Optional	Optional	Optional	Optional

Descriptions

Connection	Description
1	The incoming +12 or 24 Volt needs to be connected to this terminal. Take good care that you do not connect this when the 12 Volt is active. Also take care that the incoming wire is well under the terminal. This connection has no safety against reverse polarity or is protected by a fuse. This needs to be installed outside the tripmaster. We would recommend to use the constant 12 Volt and not an accessory or switched 12 Volt. You do not want always to start the complete device when (re)starting your vehicle.
2	Not Connected (Future idea 😊). It is still directly connected to the processor so be sure there is nothing connected.
3	Incoming GND. Please connect this to the mass of the vehicle
4	Connect the first sensor to this terminal.
5	Connect the second sensor to this terminal.
6	If you want to operate the SELECT button of the second (bottom) display with an external button, you must use a Normally Open button to this terminal. The other pin of the button you need to connect to the GND (can be anywhere in the vehicle).
7	This terminal is the +5 Volt output for the external display(s).
8	This terminal is the signal output for the external display(s).
9	This terminal is the GND output for the external display(s).
10	If you want to connect an external button or the reverse lights to the tripmaster to enable the countdown mode, you need to connect the switched 12 volt of the reverse light or a Normally Open toggle button with +12 Volt on the other side, to this terminal. For more explanation, see "Countdown connection possibilities".
11	If you want to operate the STOP button of the second (bottom) display with an external button, you must use a Normally Open button to this terminal. The other pin of the button you need to connect to the GND (can be anywhere in the vehicle).
12	If you want to operate the TRIP button of the second (bottom) display with an external button, you must use a Normally Open button to this terminal. The other pin of the button you need to connect to the GND (can be anywhere in the vehicle). A lot of times this button is a footpedal . If you want to connect more than 1 button/pedals, you can connect them parallel so that if one of them is pressed, the tripmaster will see a button press.

Countdown connection possibilities

There are a couple of possibilities to make the connections:

- Only the reverse lights
- Only a toggle switch
- The reverse lights and a toggle switch

If you want to be able to also stop the distance measurement, you can replace the normal toggle switch with a 3-stand toggle switch and connect the pulses from the sensors to this switch.

Only the reverse lights

When you want to do this, you only need to connect the port of the tripmaster to the wire between the gearbox sensor and the reverse light. You can do this (ofcourse) at the lightbulb or at the sensor side.

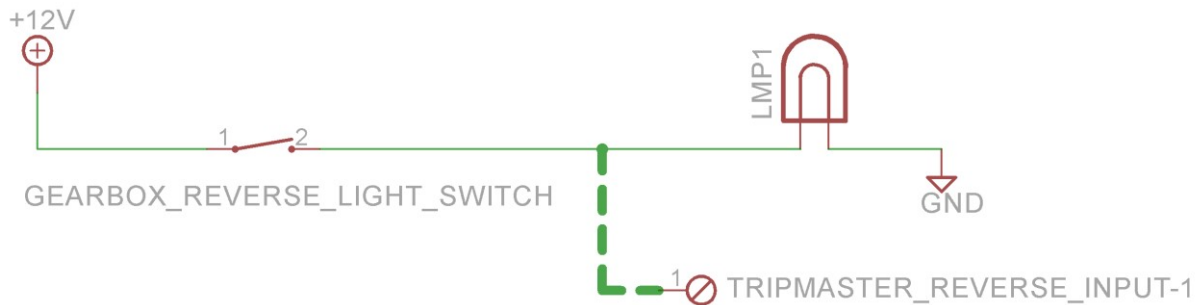

Only a toggle switch

When you want to do this, you only need to connect the port of the tripmaster to the switch and connect a +12 Volt to the other side of the switch.



The reverse lights and a toggle switch

This is a combination of the above mentioned connections. What needs to be added is a diode in the line to the reverse light. Otherwise your reverse light will light up when you flip your switch. While the currents are very low and the voltage range quiet big, you can use almost any diode that you can find. If you want, KRE can also supply a diode..

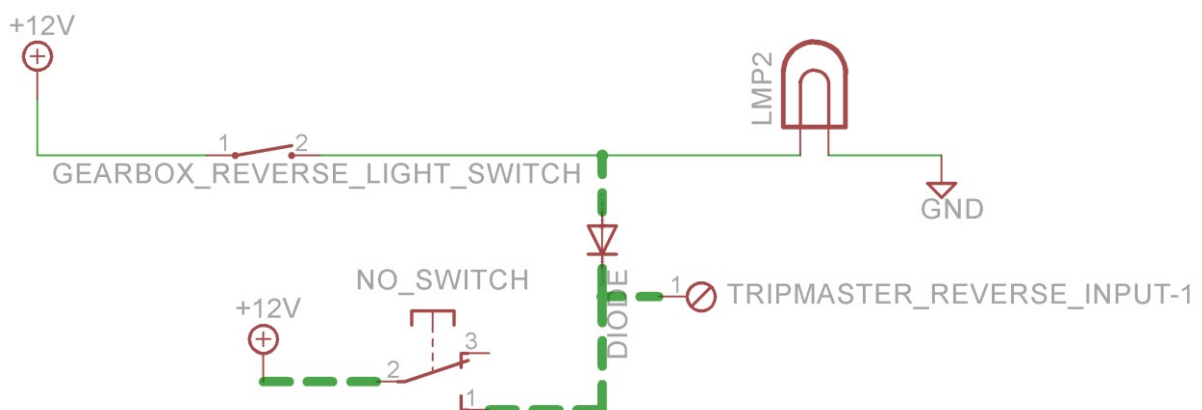

Connect a 3-way toggle switch to add a non-counting possibility

For this, you have to change the toggle switch connection in the above schematics. You can use a 3PDT with ON-NONE-ON or ON-OFF-ON characteristics. This is a switch with 12 pins (or sometimes some pins are left out) . You have to connect the signal lines of the sensors also through the switch and connect it according the below schematic. In this way, you should have three possibilities: Count normal, non counting and count backwards.

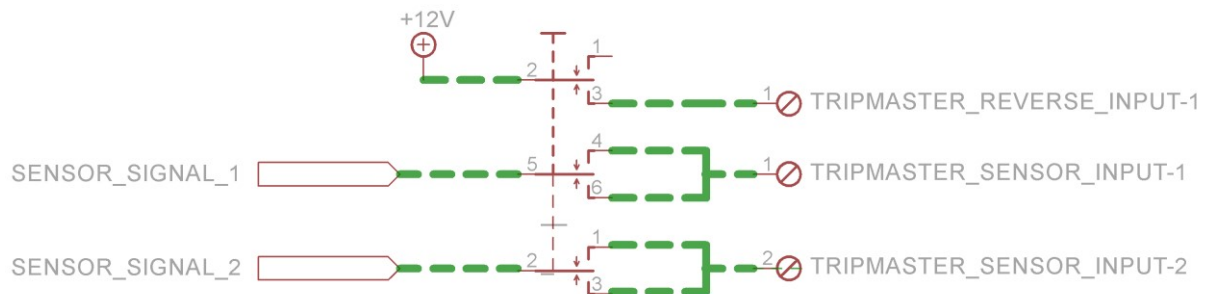

Sensors

At KRE we have several sensors. In principle, all sensors that are NPN sensors will work. A NPN sensor is basically a sensor that makes a connection to the Ground when it is activated.

A normal sensor has 3 wires:

- Brown → Connect to +12 Volt
- Black → Connect to the sensor input of the tripmaster
- Blue → Connect to GND

A cable sensor has also 3 wires:

- Red → Connect to +12 Volt
- White → Connect to the sensor input of the tripmaster
- Black → Connect to GND

If you have an electronics Speedometer that does not get the speed from the canbus of the car, you can probably connect the tripmaster directly to the sensor in the car. You can connect the wire that goes from the speedometer gauge to car's sender directly in the tripmaster. Ofcourse you keep the original speedometer connected.

In some modern cars that use the can bus signal, there is an onboard pulse available that is used for the speed measurement for an aftermarket radio. You should be able to use this pulse also..

Dimmable Light mode

With the  button the light can be switched between full light and a dimmable mode for night driving. This dimmed mode can be adjusted by adjusting the potentiometer that is marked with the purple circle on the overview figure. This can be adjusted with a small screwdriver when the dimmable mode is activated and can be adjusted to the desired level.

Manual Distance adjustment buttons

For the manual distance adjustment we need to connect two buttons; a button to decrease the distance and a button to increase the distance. These buttons can be connected on 1 side to the GND of the vehicle and on the other side to the tripmaster. The button connections you find in the pinheader(s) with the yellow circle on the overview figure. The increase button is pin 4 and the decrease button is pin 5. Pin 2 is +5Volt and pin 3 is GND. This GND can be used if you want.

It is a standard pinheader with a pitch of 2,54 mm.

The Alma Rally Plus are essentially two tripmaster in 1 enclosure. Therefore your external buttons need to be connected to both tripmasters when you want to be able to adjust them both. You can connect them simultaneously to a button.

Separate TRIP1 from display 1 from TRIP1 from display 2

With this jumper you can detach the external trip reset button (button and/or footpedal) from the internal trip reset button . If you separate them you essentially make an extra resettable trip1 on the device but TRIP1 are not the same anymore on both displays. The normal operation is the jumper between pin 1 and 2. For separation of the buttons, the jumper goes between pin 2 and 3 or is left out completely..